

# **Clip CH50 V2**

## **Thermal Imaging Attachment**

### **User Manual**

V1.1

IRay Technology Co., Ltd.

## Contents

1. Description.....	4
2. Components and Controls.....	5
2.1 Components .....	5
2.2 Controls.....	6
3. Menu/Status Bar Icons.....	7
4. Specifications.....	8
5. System Function .....	9
6. Operation System.....	10
6.1 Power on / Power off .....	10
6.2 Standby Mode .....	10
6.3 Status bar.....	10
6.4 Navigation Menu .....	10
6.5 Advanced Menu .....	11
6.6 Calibration the sensor .....	13
6.7 Image Calibration.....	14
6.7 E-Zoom center adjustment.....	15
6.8 Bad Pixel Calibration.....	15
6.9 Compass Calibration.....	16
6.10 Stadiametric Rangefinder.....	17
7. Accessory Equipment .....	19
7.1 Bluetooth Remote Controller.....	19
7.2 Mobile App .....	20
8. Preventative Maintenance.....	21
8.1 Battery Installation.....	21
8.2 Product Cleaning and Maintenance .....	22
8.3 Safety Regulation.....	22
9. General Trouble Shooting.....	23
10. Appendix.....	24

---

10.1 User Interface Description .....	24
10.2 Product Dimensions .....	24
10.2.1 Boundary Dimension .....	24
10.2.2 Bottom Mounting Hole Size .....	25

## 1. Description

Clip CH50 V2 is a front attachment designed as the infrared expansion device of the day-light sight. Different from the night vision device based on image enhancement, Clip CH50 V2 doesn't need external light source and isn't influenced by strong light exposure. It can be used in the night or bad weather conditions such as fog, rain, smog and can detect the objects through obstacles such as branch, tall grass, dense bushes and so on. Clip CH50 V2 has a wide range application including night hunting, observation and terrain orientation, search and rescue operations.

Using the Clip Series Front Attachment includes several benefits over night hunting with traditional optics or even the night vision devices. Attaching the Clip Series to a traditional scope delivers the same creature comforts of shooting with day optics you are accustomed to, including your existing reticle and eye relief. The Clip Series Front Attachment even allows you to continue utilizing your riflescope's variable magnification.



Fig. 1-1 Clip CH50 V2 thermal imaging attachment

## 2. Components and Controls



Fig. 2-1 Function introduction

### 2.1 Components

No.	Name	Function description
①	Lens Cap	Protecting the lens and using for background correction
②	Objective Lens	——
③	Lens Focus knob	Used to adjust the focal length of objective lens to make the image to be the clearest when the image is indistinct.
④	Power(P) Button	Power on/Power off/Standby/Up/Left
⑤	Menu(M) Button	Entering menu/Parameter switch
⑥	Correction(C) Button	Shutter correction/Background correction /Down/Right
⑦	Attachment's Eyepiece	Eyepiece as the infrared expansion attachment of day sight
⑧	Bayonet-type ring of attachment's eyepiece	Used to lock the adapter ring between the day light sight and the attachment
⑨	Battery Compartment Cover	Using two batteries which are CR123, CR123A or 16340 to supply power.
⑩	Type-C Interface	Used for data communication and external power supply

## 2.2 Controls

Operation in normal display mode			Operation in menu mode/calibration interface		
	Short Press	Long Press		Short Press	Long Press
<b>P (4) Button</b>	Standby/ Awaken	Power on / Power off	<b>P (4) Button</b>	Adjust parameter /Scroll up options	——
<b>M (5) Button</b>	Enter the Menu Navigation	Enter the advanced menu	<b>M (5) Button</b>	Function switch / Parameter selection	Save and exit menu
<b>C (6) Button</b>	Shutter Calibration	Background Calibration	<b>C (6) Button</b>	Adjust parameter/Scroll down options	——
<b>M (5) Button + P (4) Button</b>	——	Enter stadimetric rangefinder interface	<b>P (4) Button</b>	Increase the distance between measurement bars	Quickly zoom in
			<b>M (5) Button</b>	——	Exit
			<b>C (6) Button</b>	Reduce the distance between measurement bars	Quickly zoom out
<b>P (4) Button + C (6) Button</b>	——	Enter the compass calibration interface			

## 8. Menu/Status Bar Icons

	Screen lightness setup—four levels
	Image mode: B (Black hot), W (White hot), R (Red hot), C (Pseudo Color)
	Image Sharpness: levels 1-4
	E-zoom (Only for Monocular: ×1, ×2, ×4)
	Ultraclear mode
	Bluetooth option
	Bluetooth connected
	Video output option
	Video output is on
	Auto shutter calibration
	Reticule type, four customize sorts
	Battery type selection
	More
	Image calibration
	E-Zoom center adjustment
	Bad pixel correction option
	Factory reset
	Return to the main menu
	Battery capacity indicator
	Type-C power supply
	Orientation shift

## 4. Specifications

Model	Clip CH50 V2
<b>Detector Parameters</b>	
Detector Type	Vox Uncooled
Resolution	640*512
Pixel Size	12um
NETD	≤40mk
Frame Rate	50Hz
<b>Optics Parameters</b>	
Objective Lens	50mm
Field of View	8.8°×7.0°
Recommended magnification of the day sight	×1-×9
E-zoom	×1 / ×2 / ×4
Detection Range (Target size: 1.7m×0.5m, P(n)=99%)	2597m
<b>Display Parameters</b>	
Type	OLED
Resolution	1024×768
<b>Electrical Parameters</b>	
Battery	CR123×2 / 16650×2
Max. Battery Life	4h / 7h
Power Consumption	<1200mW
<b>External Interface</b>	
USB Interface	Type-C
Video Output	PAL (RCA Port)
External Power	Type-C
<b>Functions</b>	



Digital Compass	√
Motion Sensor	√
Remote Control	Bluetooth
<b>Physic Parameters</b>	
IP Rating	IP66
Weight (without batteries)	<570g
Dimension	175mm×74mm×68mm
Adapter Ring	M52×0.75

## 5. Product Characteristics and Function

- 12μm thermal imaging detector
- Detection range beyond 2.5km
- 1024×768 high resolution AMOLED display
- No rezeroing required and quick attached
- 48mm long focal length eyepiece
- E-zoom with aiming accuracy unaffected
- Familiar precision
- Bluetooth remote control
- Four image modes – white hot, black hot, red hot, pseudo color
- Monocular digital zoom: ×1, ×2, ×4
- Recommended magnification of the day sight: ×1-×9
- Type-C interface power supply and data transmission
- PAL analog video output
- Build-in compass, motion sensor
- IP66 protection level
- Compact size and great impact resistance

## 6. Operation System

### 6.1 Power on / Power off

Press and hold down **P (4)** button for 3s to start up the device, the image appears on the display screen. After 6s, the device is turned on.

Press and hold down **P (4)** button for about five seconds to shut down the device.

### 6.2 Standby Mode

Enter/exit the standby mode with pressing the **P (4)** button briefly for power saving.

### 6.3 Status bar

The status bar is located at the bottom of the screen, which shows information such as image mode, screen brightness, E-Zoom, Reticule types, Sharpness, Bluetooth (on), ultra-clear mode (on), video out (on), battery status.

### 6.4 Navigation Menu

In the normal display interface, press **M (5)** button briefly to switch in the order of "none menu - screen brightness - image mode - sharpness - E-zoom - exit the navigation menu". And press **P (4)** button and the **C (6)** key to adjust the parameters of each function. Navigation menu interface is as shown in fig. 6-1.



Fig. 6-1 Navigation Menu

- **Screen brightness:** 1~4 brightness level.
- **Image mode:** W (White hot), B (Black hot), R (Red hot), C (pseudo color).

- **Image sharpness:** 1-4 levels of sharpness.
- **E-zoom:** ×1/×2/×4.

## 6.5 Advanced Menu

Press and hold down the **M (5)** button for three seconds to enter the advanced menu interface (fig. 6-2). The six functional options from top to bottom are Ultraclear mode, Bluetooth, video out, auto shutter calibration, image calibration type, battery type and more.

In the submenu of the more function, functions such as image calibration, E-zoom center adjustment, bad pixel correction, factory reset and return to the main menu can be selected. Please referring to table 6-1 for details.

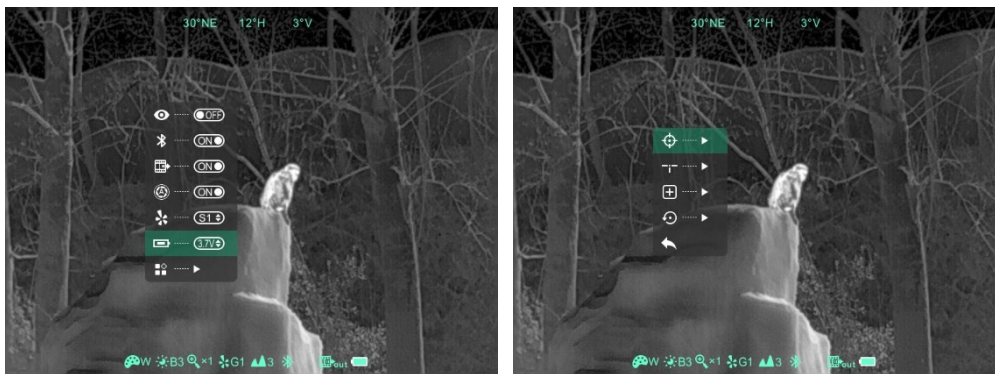









Fig. 6-2 Advanced menu interface





### Operations:

- In the advanced menu, press **M (5)** button briefly to adjust the parameters of present option or enter the secondary menu.
- **P (4)** button is used to shift up or left. **C (6)** button is used to shift down or right;
- Press and hold down **M (5)** button for three seconds to exit advanced menu interface.

**Table 6-1 Advanced menu function description**

Icon	Name	Function	Description	Status
	Ultraclear Mode	Conversion of normal mode and Ultraclear mode	In this mode, the image contrast is enhanced, which is suitable for cloudy, rainy, foggy and other harsh	The icon displays at the status bar.

			weather conditions	
	Bluetooth	ON/OFF	When Bluetooth is on, it can be operated with the Bluetooth remote controller or mobile phone APP (please search for connection by mobile phone within 1 minute, otherwise, the Bluetooth will be automatically turned off ).	The icon displays at the status bar.
	Video Output	ON/OFF	Transfer the analog video in PAL through the Type-C data cable.	The icon displays at the status bar.
	Auto shutter calibration	ON/OFF	When this function is on, the device can automatically perform the shutter calibration.	_____
	Image Calibration Type	G1/G2/G3/G4	Up to four groups of calibration data can be stored	The icon displays at the status bar.
	Battery Type	3V/3.7V	Select 3V or 3.7V depends on the voltage of battery	The icon displays at the status bar.
	More	Open the submenu	More functions can be selected.	
	Image Calibration	Enter image calibration interface	Shifting infrared images, ensure daylight & infrared images are in the same	Image Calibration interface (fig.

			location	6-3)
	E-zoom center adjustment	Enter the E-zoom center adjustment interface	Shift the zooming center to align with day rifle scope's reticle	E-zoom center adjustment interface (fig. 6-4)
	Bad Pixel Correction	Calibrate the bad pixels on the image	Refer to 6.8	Bad pixel calibration interface (fig. 6-5)
	Factory Reset	Restore factory state	Y: Confirm, N: Cancel Press and hold <b>M</b> button to save and exit.	_____
	Return	Return to the main menu	_____	_____

## 6.6 Calibration the sensor

When the image is degraded or uneven, it can be improved by calibration. Calibration enables the detector temperature background to be equalizes and defects in the image to be eliminated.

There are two calibration mode: manual and automatic.

- Auto shutter calibration: when the auto shutter calibration is on through the main menu, the device is calibrated automatically by the software algorithm. The sensor is closed by an internal shutter.
- Manual calibration: the device needs to be calibrated manually. In the home screen, short press the **C (6)** button to perform the shutter calibration, and long press for the background calibration. The lens cap should be closed before performing the background correction.

## 6.7 Image Calibration

When the device is installed on the day light sight as an infrared extension component, if the reticle of white light sight is not in the center of infrared image, the image calibration function can be used to shift the infrared image to ensure the position consistency between the white light image and infrared image.

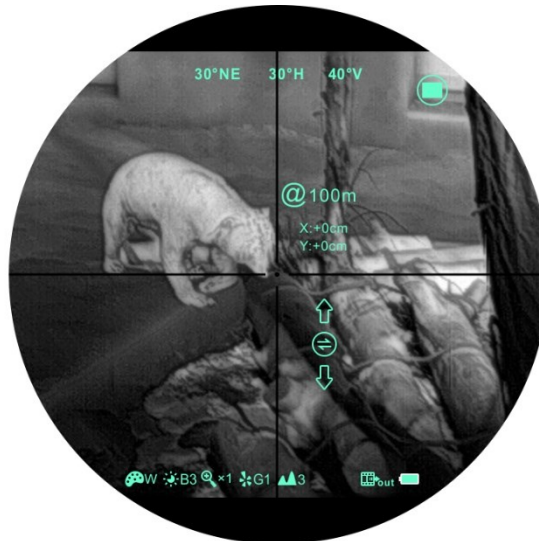

Fig. 6-3 Image calibration interface

### Operation:

- Please calibrate the day light sight before mounting Clip CH50 V2.
- Installing Clip CH50 V2 on the day light sight and repeat the calibration steps above. Then aiming at the target at 100 meters and shoot. Measure the horizontal distance and vertical distance between the bullet hitting point and the aiming point afterwards.
- In normal display mode, press and hold down **M (5)** button to enter the image calibration interface. Pressing **P (4)** button or **C (6)** button briefly to move the position of infrared image and long press to achieve quick shift. Pressing **M (5)** button to switch the orientation of X-axis (left-right) and Y-axis (up-down) while the moving distance is displayed synchronously above the icon. (as shown in figure 6-3)
- When the calibration is done, long press **M (5)** button to save and exit the calibration interface.

**Note: Before zeroing function performs, please confirm the storage location, i.e., selection of the type of zeroing. (Refer to 6.5 for details)**

## 6.7 E-Zoom center adjustment

- Please calibrate the image before adjusting E-zoom center.
- Hold down **M (5)** button to enter advanced menu, select E-zoom center adjustment option to enter the menu.
- In the adjustment menu, move white reticle until it overlap with day light scope's reticle.
- Hold down **M (5)** button to save and exit the adjustment interface. Aim the target with E-Zoom, observe if the center of E-zoom overlap with reticle of day light scope. Repeat previous center adjustment if there is deviation.



Fig. 6-4 E-zoom center adjustment

## 6.8 Bad Pixel Calibration

- When enter the advanced menu, select the bad pixel calibration option and press **M (5)** button briefly to enter the bad pixel calibration interface (fig.6-5). A reticle will appear in the center of the screen.
- Then, move the reticle up-down or left-right to select the bad pixel by pressing the **P (4)** button and **C (6)** button. Press **M (5)** button briefly to switch the orientation of X-axis (left-right) and Y-axis (up-down).
- After selecting the bad pixel, press **P (4)** and **C (6)** button at the same time to

calibrate the bad pixels.

- Repeat the above operations to continue selecting bad pixel, and the status bar at the bottom of the screen will display the number of calibrated bad pixels.
- When the calibration is done, press and hold **M (5)** button to exit the bad pixel correction.



Fig. 6-5 Bad pixel correction interface

## 6.9 Compass Calibration

- In the home screen, press and hold the **P (4)** and **C (6)** button at the same time to enter the compass calibration interface.
- An icon like a triaxial coordinate system appears on the screen (shown as fig. 6-6).
- Follow the icon prompt to rotate the riflescope along three axes at least 360 degrees each axis in the 15 seconds.
- It will automatically exit and complete compass calibration after 15s.
- During the calibration process, press **P (4)** button briefly to exit the compass calibration interface at any time.



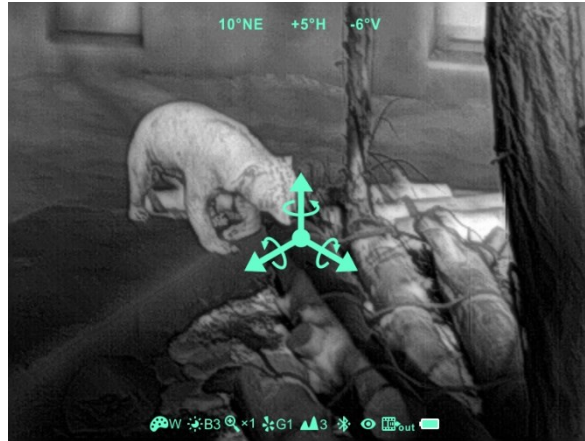

Fig. 6-6 Compass calibration interface

## 6.10 Stadiametric Rangefinder

Stadiametric rangefinder is only for monocular mode that can estimate approximate distance to an object of known size.

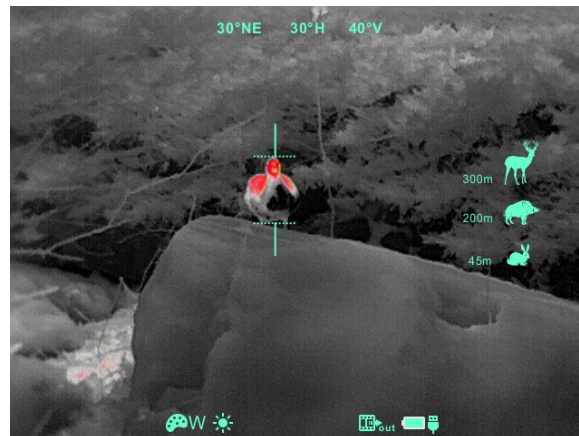

Fig. 6-7 Stadiametric rangefinder interface

- In the home screen, press and hold the **P (4)** and **C (6)** button for 3s at the same time to enter the stadiametric rangefinder interface (fig. 6-7).
- The display will show two horizontal lines for measurement, the icons and numbers of the measured distance for three objects on the right.
- There are three predefined values for objects:
  - **Deer** – height 1.7m
  - **Boar** – height 0.9m
  - **Hare** – height 0.2m
- Locate the target by pressing **P (4)** button or **C (6)** button until the target matches

entirely between the two measurement lines. **P (4)** button is used to increase the distance and **C (6)** button to reduce the distance.

- The distance to the target is automatically recalculated while moving the measurement lines and displayed on the left of the three reference objects.
- The center and color of the measurement lines is the same as the reticle.
- Exit the rangefinder mode with a long press of the **M (5)** button.

## 7. Accessory Equipment



Fig. 7-1 Remote controller

Clip CH50 V2 is equipped with external devices that can be connected via bluetooth. The button layout of the bluetooth remote controller and mobile phone APP is consistent with the device, including Power button, menu button and correction button. The functions and operation methods are also corresponding with the device. (Refer to figure 7-1 and 7-2 for details)

### 7.1 Bluetooth Remote Controller

- Install a CR2030 button battery (purchased by yourself) on the remote controller.
- Turn on the Bluetooth of the device and the icon will show at the bottom of the screen.
- Long press the Power button on the remote controller for 15 to 30s until the bluetooth icon on the screen turns to  , which means connected and the remote controller is ready to use.
- After connecting to the device, if the signal is disconnected in between, the bluetooth remote control will continue to search for connection within 1 minute.
- Turn off the bluetooth on the device, and the remote controller will automatically shut down if no bluetooth signal is found within 1 minute.

## 7.2 Mobile App

- Download and install the APP named Xinfared BC from Google play on your smart phone.
- Turn on the bluetooth of the device and the bluetooth icon will show at the bottom of the screen.
- Open the APP, select and connect with the device within 1 minute until the message “connect device success” appears on the top of the APP interface.
- And at the same time, the bluetooth icon on the device turns to .
- Click the remote icon on the APP to enter the operation interface (fig.7-2), then operate the Clip CH50 V2 with the mobile phone.

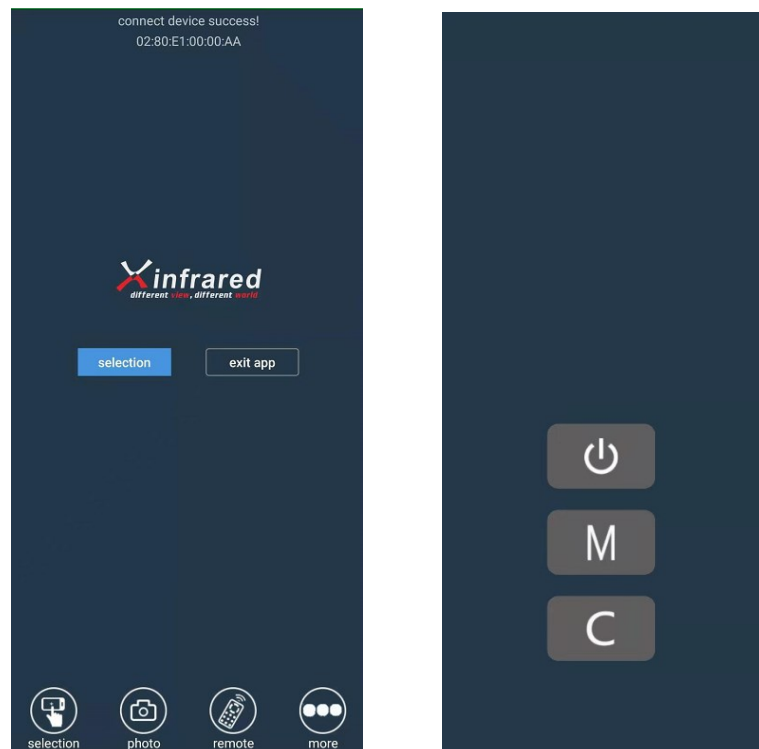



Fig. 7-2 App interface

## 8. Preventative Maintenance

### 8.1 Battery Installation

- When the icon  is appeared on the status bar, please replace with new batteries;
- It is necessary to power off before replacing the batteries.
- Turn the **battery compartment knob (10)** in a counterclockwise to open and remove it.
- Install two CR123 batteries correctly according to electrode instructions on the label inside the battery compartment as shown in fig. 8-1.
- Replace the battery cover and press heavily until heard clicking sound and make sure the cover is closed on both sides correctly.
- After installation, please set the battery type in the advanced menu for the first starting up--choosing 3.7V or 3V (referring to the instructions of the section 6.5), otherwise the battery level indication will be inaccurate and may be interrupted during operation.

#### Note:

- **Disposable batteries are be suggested only. That is risky when using the rechargeable batteries, due to inconsistent quality.**
- Please do not use batteries of different types or batteries with various charge levels.



Fig. 8-1 Schematic diagram of battery installation

- The Clip C series also supports the extended use of 16650 batteries with the InfiRay's extra battery accessory, to increase the working time of the product up to

7 hours, referring to the fig.8-2.



Fig. 8-2 Installed diagram of the 16650 batteries

## 8.2 Product Cleaning and Maintenance

- It is prohibited to clean the device with the cleaning tool which may corrode or scratch optical glass.
- The unit can be scrubbed with soft cloth by dipping certain amount of alcohol.
- For optical glass devices such as eyepiece lens and objective lens, dust should be blown first, and then use charcoal pen or degreasing cotton dipping non-methylated alcohol to wipe slightly.

## 8.3 Safety Regulation

- Please use standard batteries. Do not throw the batteries away or put them into fire after usage.
- Please use standard charger to prevent the product from damage.
- Short circuit products are prohibited.
- It is prohibited to expose the product in high temperature environment more than 60°C.
- It is prohibited to put the product into fire.

## 9. General Trouble Shooting

**Table 9-1** General trouble shooting

Description	Probable cause	Trouble shooting
Image blurring	The focal length of the objective lens does not suit.	Adjust the focal length of objective lens until the image becomes clear.
	No image calibration for a long time.	Perform image calibration.
Blurred vision	Sight distance inadequacy.	Adjust the sight distance of eyepiece until image becomes clear.
No analog video output	Analog video not opening.	Open analog video output.
	Data cable doesn't support data transmission.	Replace data cable.
Fail to start up	Wrong battery installation or low power.	Check the battery installation and battery power.
	Insufficient external supply voltage.	Check the voltage of external power supply.
The attachment's eyepiece is stuck during installation.	Eye relief mounting limit block isn't placed parallel to the rail slot and the position is dislocation.	Loose the eyepiece, push it back to square, and then rotate the mounting.
When aiming at target, the reticle swings and cannot be aimed at the target.	The day light sight parameter is not the correction distance of 100 yards.	Replace the day light sight with a 100-yard sight.

★Please contact with us as soon as possible if there are some abnormalities. Private disassemble is strictly prohibited.

## 10. Appendix

### 10.1 User Interface Description

- Custom interface and data cable are adopted to support type-c power supply, serial port and PAL video.
- Support type-c and battery power supply, support over-voltage and under-voltage reverse connection protection.

### 10.2 Product Dimensions

#### 10.2.1 Boundary Dimension

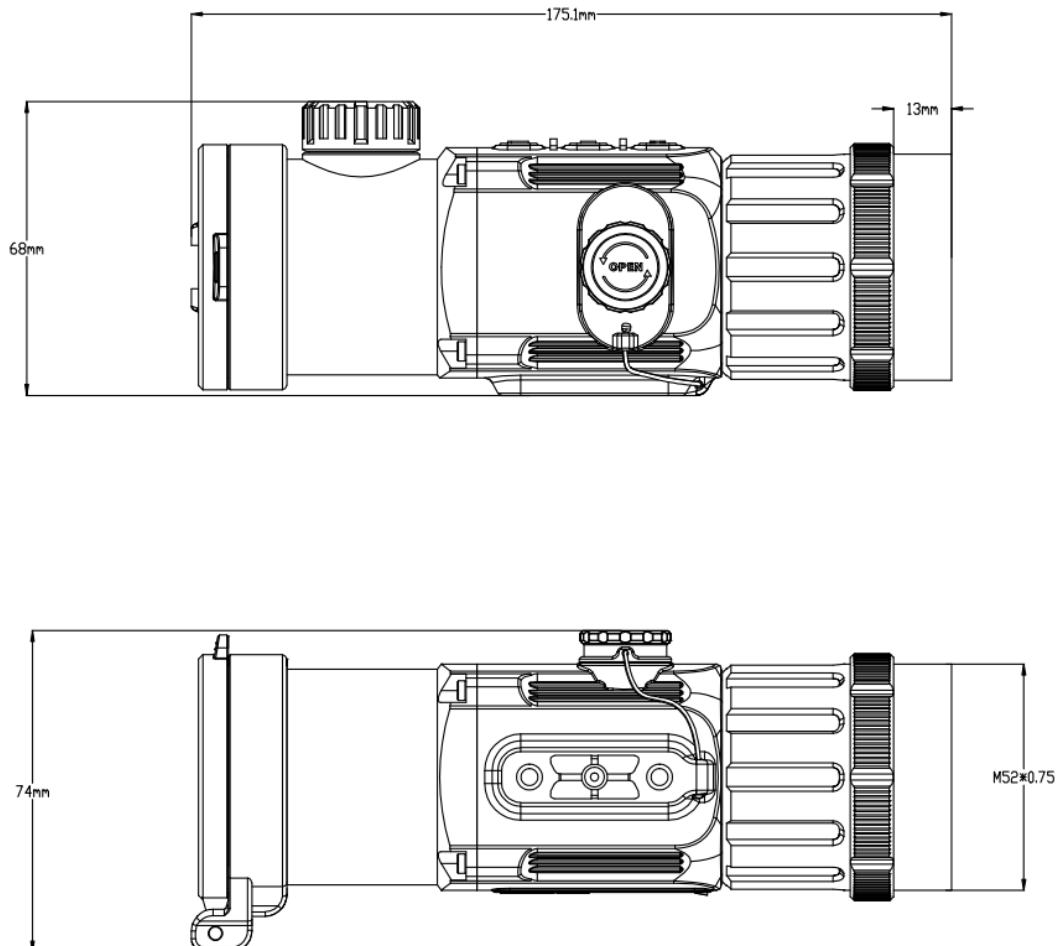



### 10.2.2 Bottom Mounting Hole Size

